

# Luminaria Reflectora Serie LHS



Para exteriores.



LHS-40



LHS-10

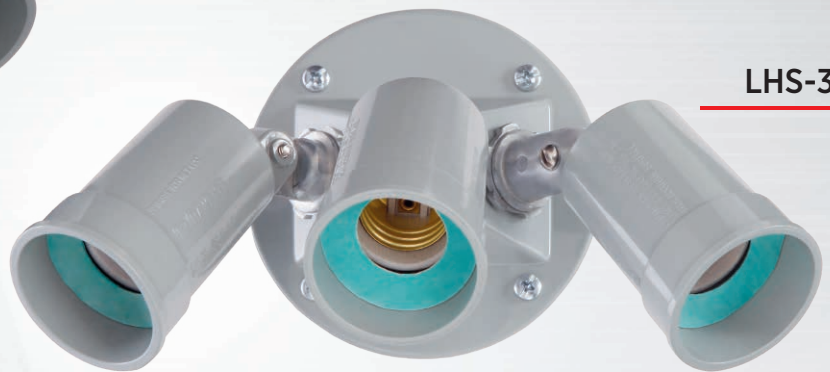

LHS-30

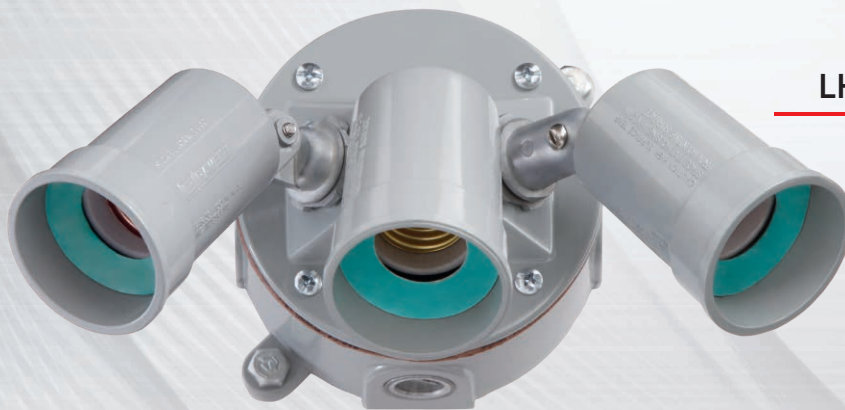

LHS-60



LHS

Outdoor Floodlight LHS Series

18.1

## LUMINARIA REFLECTORA. PARA EXTERIORES. SERIE LHS

- Para uso en seguridad o recreacional, para iluminar banquetas, caminos peatonales, entradas, jardines, etc.
- Fabricación robusta de Zamac inyectado a presión.
- Pintura electroestática epóxica/poliéster polimerizada termoendurecible (Horneada).
- Socket de porcelana con cables de 150 mm.
- Empaque para altas temperaturas incluido.
- Acepta lámparas incandescentes, base media hasta 100 w. Par 38 o su equivalente en LED autobalastadas, CFL fluorescentes compactas y halógenas.
- Brazo giratorio con rosca 1/2" NPT con seguro para direccionamiento de portalámpara y tuerca para posicionamiento permanente.
- Se surte sin foco.
- Fabricación en base UL-1598.

18.1

## OUTDOOR FLOODLIGHT. LHS SERIES.

- For use in safety, security and recreational, lighting in entrance ways, driveways, walkways, gardens, etc.
- Heavy duty diecast Zinc construction.
- Electrostatic powder epoxic/polyester coating.
- Porcelain socket with 6" wire leads.
- Gasket for high temperatures included.
- Accepts outdoors medium base incandescent up to 100 w. Par 38 or the equivalent in selfballasted LED, CFL compact fluorescent, and halogen lamps.
- Locking swivel arm 1/2" NPT threaded to allow positive lamp positioning and pin-point directional aiming.
- Shipped without lightbulb.
- Manufactured in compliances with UL-1598.

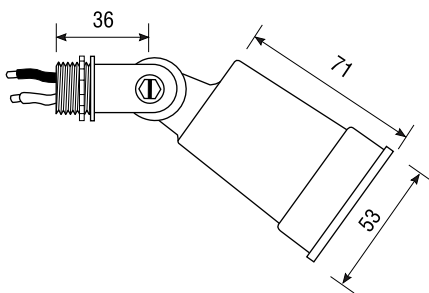
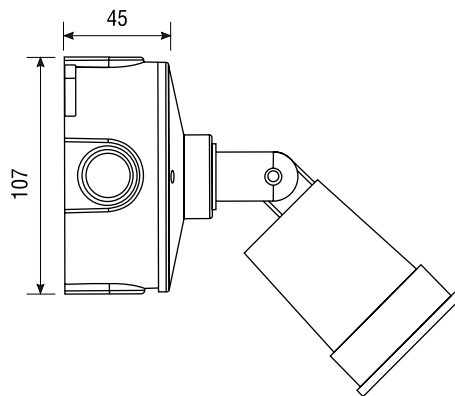
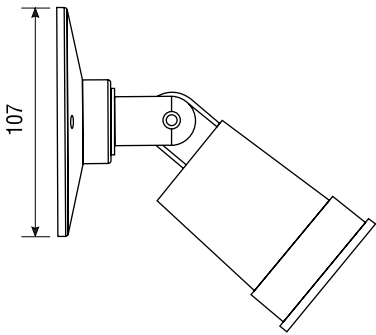

Acotaciones en mm  
Dimensions in mm

Cumple con /  
Compliances:  
UL 1598  
CSA C22.2 No. 250  
NMX-J-307-ANCE-2017  
NMX-J-627-ANCE-2009  
NMX-J-529-ANCE-2012



Manufacturing and Integration 100% National.  
Made in Mexico

RAWELT, S.A. de C.V.

Torreón, Coah., México  
Tel: 871 747 47 84 / Ventas: 800 999 20 18  
torreon@rawelt.com.mx



www.rawelt.com.mx

**RAWELT**  
Una División del Grupo REVUELTA

Serie LHS Sección 18.1 | **RW41**

24-05

# 18.1 - LUMINARIA REFLECTORA PARA EXTERIORES. SERIE LHS.

# 18.1 - OUTDOOR FLOODLIGHT. SERIES LHS.

**007 - RW - 320**

- Para uso en seguridad ó recreacional, para iluminar banquetas, caminos peatonales, entradas, jardines, etc.
- Construcción robusta aluminio inyectado a presión. (Diecast)
- Acabado: Pintura electrostática epóxica/poliéster polimerizada espesor mínimo de 2 mils
- Pruebas en cámara salina a pintura de acuerdo a ASTM B117
- Pruebas de adherencia a pintura de acuerdo a ASTM 3359
- Resistencia a impactos mecánicos en cuerpo de acuerdo a IK09, gracias a su diseño que no cuenta con elementos susceptibles a rompimiento.
- Socket de porcelana con cables de 150 mm.
- Empaque incluido.
- Acepta lámparas para intemperie incandescentes base media hasta 100 w. Par 38 o su equivalente en LED Autobalastada, halógenas, (CFL) fluorescente compacta.
- Brazo giratorio con rosca 1/2" NPT asegurando continuidad a tierra con seguro para direccionamiento del portalampara para permitir ajustar y enfocar la luz a el área deseada.
- Se surte sin foco.
- Fabricación en base a UL - 1598  
CSA - C22.2 No. 250.0
- Roscas NPT asegurando continuidad a tierra.

- For use in safety, security and recreational lighting in entrance ways, driveways, walkways, gardens.
- Heavy duty diecast aluminum construction
- Finish: Electrostatic powder coating epoxic/polyester. Minimum thickness 2 mils.
- Saline chamber test to paint according to ASTM B117.
- Paint adhesion test according ASTM 3359.
- Resistance to mechanical impacts according IK09 body, thanks to its design that does not have elements susceptible to breakage.
- Porcelain socket with 6" wire leads.
- Gasket included
- Accepts outdoors medium base, incandescent up to 100 w. Par 38 or the equivalent in halogen and (CFL) compact fluorescent lamps medium base.
- Locking swivel arm 1/2" NPT threaded to ensure ground continuity to allow adjust lamp in any position to focus in the desired spot.
- Shipped without bulb.
- Manufactured in compliances with UL - 1598  
CSA - C22.2 - No.250.0  
NPT threaded to ensure ground continuity.

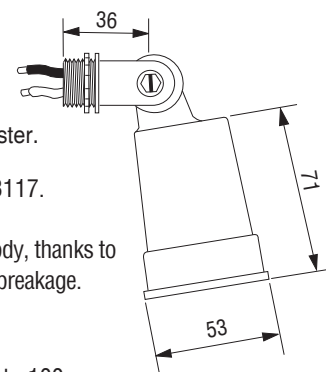

USAR No. DE CODIGO PARA HACER PEDIDOS. TO ORDER USE CODE NUMBER.

Figura Figure	Descripción Description	Catalogo Catalog	Código Code	Salida Hub size		Peso x 100 pzas. Weight x 100 pcs.		Pqt. Unit Pzas. Pcs.	Unit Ctn. Pzas. Pcs.	Ship Ctn. Pzas. Pcs.	Std. Pkg. Pzas. Pcs.
				mm	inch	kg	lb				
	Luminaria reflectora sencilla LHS Single outdoor floodlight LHS	LHS	27.10.3297	12.7	1/2	25.0	55.0		16	48	
	Luminaria reflectora sencilla LHS, tapa TCSX, empaques y tornillos. Single outdoor floodlight LHS, TCSX cover, gasket and screws.	LHS-10	27.10.3492	12.7	1/2	34.5	76.0		10	30	
	Luminaria reflectora sencilla LHS, tapa TSX, empaque y tornillos y tapon. Double outdoor floodlight LHS, TSX cover, gasket, screws and closure plug.	LHS-20	27.10.3493	12.7	1/2	70.0	154.0		6	18	
	Luminaria reflectora triple LHS, tapa TSX, empaques y tornillos. Triple outdoor floodlight LHS, TSX cover, gasket and screws.	LHS-30	27.10.3494	12.7	1/2	95.0	209.0		5	15	

Especificaciones sujetas a cambio sin previo aviso. Specifications are subject to change without notice.

**RAWELT, S.A. de C.V.**

**RAWELT** ® INYECTADOS  
Una División del Grupo REVUELTA

**18.1 - LUMINARIA REFLECTORA PARA EXTERIORES. SERIE LHS.**







Hoja: 2 / 3  
Page:

**18.1 - OUTDOOR FLOODLIGHT. SERIES LHS.**

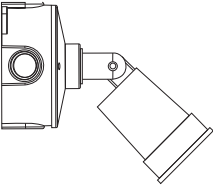
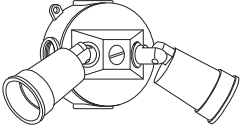
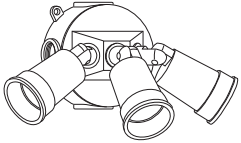
FICHA TECNICA / TECHNICAL DATA

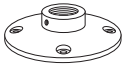
**007 - RW - 320**

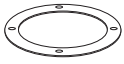
USAR No. DE CODIGO PARA HACER PEDIDOS. TO ORDER USE CODE NUMBER.

Figura Figure	Descripción Description	Catalogo Catalog	Código Code	Salida Hub size		Peso x 100 pzas. Weight x 100 pcs.		Pqt. Unit Pzas. Pcs.	Unit Ctn. Pzas. Pcs.	Ship Ctn. Pzas. Pcs.	Std. Pkg. Pzas. Pcs.
				mm	inch	kg	lb				
	Luminaria reflectora sencilla LHS, tapa TCSX, caja estandar CSX, empaques, tornillos y tapones. Single outdoor floodlight LHS, TCSX cover, standar box CVX, gasket, screw and closure plugs.	LHS-40	27.10.3495	12.7	1/2	60.5	133.0		5	15	
	Luminaria reflectora doble LHS, tapa TSX, caja estándar CSX, empaques, tornillos y tapones. Double outdoor floodlight LHS, TSX cover, standar box CVX, gasket, screws and closure plugs.	LHS-50	27.10.3496	12.7	1/2	96.0	211.0		4	12	
	Luminaria reflectora triple LHS, tapa TSX, caja estándar, empaques, tornillos y tapones. Triple outdoor floodlight LHS, TSX cover, standar box CVX, gaskets, screws and closure plugs.	LHS-60	27.10.3497	12.7	1/2	121.0	266.0		3	9	
	Caja redonda estandar CSX 102 (4) 5 Ø con 4 tapones. 4 (102) CSX standard round outlet box 5 hubs with 4 close-up plugs.	CSX-10	27.12.3353	12.7	1/2	23.0	50.7				36
	Tapa redonda TCSX 102 (4) 1 Ø roscado, con empaque y tornillos. 4 (102) TCSX round one hub cover, with gasket and screws.	TCSX-10	27.12.3356	12.7	1/2	9.3	20.5	1	6	48	70
	Tapa redonda luminaria TSX 102 (4) 3 Ø 12.7 (1/2), con empaque, tornillos y 2 tapones. 4 (102) TSX round luminaire cover 3 Ø 1/2 hubs, with gasket, screws and 2 close-up plugs.	TSX	27.12.3358	12.7	1/2	14.0	30.9	1	6	48	70
	Empaque ECSX 102 (4). ECSX gasket 4 (102).	ECSX	27.11.3262			0.400	0.88	10	70	560	
	Tapón roscado. Close-up plug.	TA-0371	01.04.0371	12.7	1/2	1.0	2.2	25	200	2000	

Especificaciones sujetas a cambio sin previo aviso. Specifications are subject to change without notice.

**RAWELT, S.A. de C.V.**

**RAWELT**® INYECTADOS  
Una División del Grupo REVUELTA

18.1 - LUMINARIA REFLECTORA PARA EXTERIORES. SERIE LHS.

Hoja: 3 / 3  
Page:

18.1 - OUTDOOR FLOODLIGHT. SERIES LHS.

FICHA TECNICA / TECHNICAL DATA

007 - RW - 320

**LUMINARIA REFLECTORA PARA EXTERIORES LHS**

**Marca: RAWELT**

**Modelo: LHS**

**Para uso exterior**

**Fuente de Luz: Instale lámpara Par 38 incandescente 100 W**

**MAX o su equivalente halógena o fluorescente**

**O instale lámpara LED autobalastada hasta 20 W MAX**

**CARACTERÍSTICAS ELÉCTRICAS**

**110 V~ 50/60 Hz 0,30 A**

**Consumo de Energía: 0,32 kWh**

**Contenido 1 pieza**

**NOM**

**País de origen: México**

**Fabricado por: Rawelt, S.A. DE C.V.**

**VALLE DEL GUADIANA 656 PARQUE INDUSTRIAL  
LAGUNERO 35070 GÓMEZ PALACIO, DGO., MÉXICO**

Especificaciones sujetas a cambio sin previo aviso.

Specifications are subject to change without notice.

**RAWELT, S.A. de C.V.**

**RAWELT** ® INYECTADOS  
Una División del Grupo **REVUELTA**

Cotización/Quotation  Plazo de embarque\* / Shipment exw\*  :

Pedido No./Purchase order  : .....

Our ref.: .....

Fecha/Date: ..... Vendedor/Salesman: ..... No. ....

Facturar a/Invoice to: ..... RFC: .....

Ordenado por/Ordered by: ..... Tel. ( ) ..... Fax ( ) .....

Dirección/Address: .....

C.P./Zip: ..... Lugar/City/Country: .....

Consignar a/Ship to: .....

Embarcar: Camión  x Cobrar  Pagado  Paquete

Cond. de Pago/Terms: .....

Cond. de Venta/Sale conditions: ..... L.P.: .....

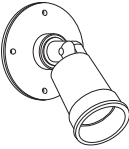
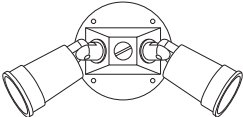
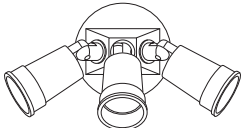
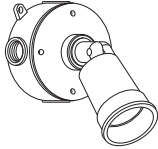
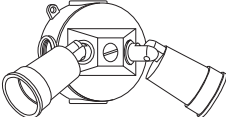
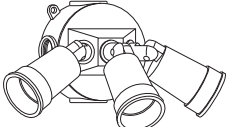
18.1 - SERIE LHS. LUMINARIA REFLECTORA PARA EXTERIORES. 18.1 - LHS SERIES. OUTDOOR FLOODLIGHT.								
Figura Figure	Código Code	Salida Hub size		Pqt. Unit	Unit Ctn.	Ship Ctn.	Std. Pkg.	Cantidad Qty.
		mm	inch	Pzas. Pcs.	Pzas. Pcs.	Pzas. Pcs.	Pzas. Pcs.	
	27.10.3297	12.7	1/2		16	48		
	27.10.3492	12.7	1/2		10	30		
	27.10.3493	12.7	1/2		6	18		
	27.10.3494	12.7	1/2		5	15		
	27.10.3495	12.7	1/2		5	15		
	27.10.3496	12.7	1/2		4	12		
	27.10.3497	12.7	1/2		3	9		

• Antes de fincar el pedido en firme, favor de confirmar con fábrica el plazo de embarque definitivo.

• Before place your order, please confirm with RAWELT definitive date of shipment.

Producción  Almacén  Embarques  Control  Expediente

Ciente

Ing. de Ventas

Cotización/Quotation  Plazo de embarque\* / Shipment exw\*  :

Pedido No./Purchase order  : .....

Our ref.: .....

Fecha/Date: ..... Vendedor/Salesman: ..... No. ....

Facturar a/Invoice to: ..... RFC: .....

Ordenado por/Ordered by: ..... Tel. ( ) ..... Fax ( ) .....

Dirección/Address: .....





C.P./Zip: ..... Lugar/City/Country: .....

Consignar a/Ship to: .....

Embarcar: Camión  x Cobrar  Pagado  Paquete

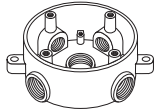
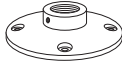
Cond. de Pago/Terms: .....

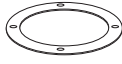
Cond. de Venta/Sale conditions: ..... L.P.: .....

18.1 - SERIE LHS. LAMPARA REFLECTORA PARA EXTERIORES. 18.1 - LHS SERIES. OUTDOOR FLOODLIGHT.								
Figura Figure	Código Code	Salida Hub size		Pqt. Unit	Unit Ctn.	Ship Ctn.	Std. Pkg.	Cantidad Qty.
		mm	inch	Pzas. Pcs.	Pzas. Pcs.	Pzas. Pcs.	Pzas. Pcs.	
	27.12.3353	12.7	1/2				36	
	27.12.3356	12.7	1/2	1	6	48	70	
	27.12.3358	12.7	1/2	1	6	48	70	
	27.11.3262			10	70	560		
	01.04.0371	12.7	1/2	25	200	2000		

Expediente  
 Control  
 Embarques  
 Almacén  
 Producción

- Antes de fincar el pedido en firme, favor de confirmar con fábrica el plazo de embarque definitivo.
- Before place your order, please confirm with RAWELT definitive date of shipment.