

Luminarias LED



A prueba de intemperie
Cerradas y Selladas



LED Weatherproof Lighting Fixture.
Enclosed and gasketed

13.4 LUMINARIA A PRUEBA DE INTEMPERIE LED. GERRADAS Y SELLADAS.

La familia V100 LED están disponibles en 2 tipos de temperatura de color: Blanco neutral y Blanco frío, ambos proporcionan una iluminación uniforme, y están diseñadas para uso interno y externo. Utilizando una tablilla con arreglos de LED podemos superar la iluminación de 300 W de luz incandescente.

- **Aplicaciones:**
 - Plantas procesadoras de alimentos, iluminación en general, pasillos, industria pesada, plantas de producción, cuartos de máquinas, ciertas planta de procesos químicos y petroquímicos, plantas de tratamiento de aguas residuales, instalaciones costa afuera y cercanas al muelle, bodegas, pasillos, cubos de escaleras y elevadores, muelles de carga, tuneles, etc.
 - En cualquier instalación marina, agroindustrial, minera, industrial o comercial.
 - Se recomienda el policarbonato para evitar la contaminación de productos alimenticios por partículas del vaso de cristal roto.
- **Material:**
 - Aluminio inyectado a presión. Diseño robusto y de alta resistencia. Diecast
 - Acabado: Pintura electrostática poliéster polimerizada por horneado. Asegurando una protección completa a corrosión y rayos UV. Color gris.
 - Vaso de policarbonato resistente al calor y rayos ultravioleta.
 - Tornillos de acero inoxidable.
 - Empaque: Silicón.
- NEMA 4, 4X. A prueba de agua sellando todas las aberturas con silicon y en las roscas de los tapones.
- No para uso residencial, si el cable de alimentación es mayor de 90°C.
- Para usarse en áreas mojadas y húmedas cuando se tenga la luminaria hacia abajo.

• **Características:**

- Resistentes a impactos y vibraciones.
- Mantenimiento mínimo o nulo.
- Encendido instantáneo.
- Excelente disipación de calor para una larga vida del LED obteniendo mayores T-RATINGS para uso en ambientes más peligrosos gracias a su diseño con aletas exteriores.
- Operación a temperaturas bajas.
- Bajas temperaturas superficiales.
- El sistema de LED puede ahorrar hasta un 85% en costos de energía.
- 50 mil horas vida pueden proporcionar más de 10 años de iluminación sin necesidad de mantenimiento.
- No contiene mercurio ni productos químicos.
- Temperaturas de operación: -30°C a 55°C.
- Tamaño compacto.
- Protección contra variaciones de corriente mediante supresor de sobrevoltajes categoría C3 10 Kv línea-tierra.

• **Vaso de policarbonato:**

- Transparente como el cristal. Alta transmisión lumínica.
- Alta resistencia al calor.
- **Clasificación de flamabilidad superior a**
UL 94 V - 0/1.2 mm o UL 94 - 5 VA/3.0 mm 2600F1, 94HB, F1.
- Alta resistencia física contra impacto, rayado o abrasión.
- Estabilidad y exactitud dimensional.
- Resistencia dieléctrica 32-35 kv/mm (1 mm de espesor de pared).
- Conserva sus propiedades físicas y químicas en un rango de temperatura de entre -40°C hasta 120°C.

13.4 LED WEATHERPROOF LIGHTING FIXTURE. ENCLOSED AND GASKETED.

The V 100 LED weatherproof lighting fixtures are available in two types of color temperature, neutral white and cool white, both has uniform illumination, and are designed for interior or exterior use, using a LED arrangements can overcome 300 watts incandescent light.

- **Applications:**
 - Food processing plants, general illumination, heavy industry, manufacturing plants, mechanical rooms, certain chemical and petrochemical processing facilities, off-shore and dockside instalations, warehouse, hallways, elevator and stairwell pits, tunnels, loading docks, etc.
 - In any marine, agroindustrial, mining, industrial, commercial facilities.
 - The Polycarbonate is recommended to avoid food contamination for particles from broken glasses.
- **Material:**
 - Diecast aluminum. Robust and heavy duty.
 - Finish: Electrostatic powder polyester coating polymerized by oven. Ensure a complete corrosion and UV rays protection. Gray color.
 - Heat and ultraviolet rays resistant polycarbonate globe.
 - Stainless steel screws.
 - Gasket: Silicone.
- Not for use in dwelling, when supply wire exceed 90°C.
- Suitable for wet and damp locations when downlight only.
- NEMA 4,4X all openings and threads are to be sealed with silicone sealing compound.
- **Characteristics:**
 - Impact and vibration resistant.
 - Minimal maintenance.
 - Instant ignition.
 - Excellent heat dissipation for a long life of LEDS getting better T-RATINGS for use in high hazardous locations through external flaps.
 - Operation at low temperatures.
 - Low surfaces temperatures.
 - 50,000 hours of life can provide more than 10 years of lighting without maintenance.
 - Contains no mercury and hazardous chemical products.
 - Operation temperatures: -30°C up to 55°C.
 - Compact size.
 - Savings up to 85% in energy costs.
 - Protection against current variations through voltage suppressor category C3 10 Kv line-ground
- **Polycarbonate globe:**
 - Clear and transparent globe, like glass.
 - High heat resistance.
 - Flammability classification up to UL 94 V - 0/1.2 mm or UL 94 - 5 VA/3.0 mm 2600F1, 94HB, F1.
 - High physical toughness against impacts and scratching.
 - Dimensional accuracy and stability.
 - Dielectric strength 32-35 kv/mm (1 mm wall thickness).
 - Keeps its physical and chemical properties in a range of -40°C up to 120°C.

Cumple con / Complies:

NEMA 4, 4X

- **CSA C22.2 No. 250**
- **NOM-030-ENER-2016**
- **NOM-058-SCFI-2017**
- **NOM-003-SCFI-2014**
- **NOM-001-SCFI-2018**
- **NOM-064-SCFI-2014**
- **NOM-024-SCFI-2013**
- **UL 8750 LED, UL 1598**
- **NMX-J-307-ANCE-2017**
- **NMX-J-627-ANCE-2009**
- **NMX-J-529-ANCE-2012**

Especificaciones eléctricas / Electrical ratings:

Lúmenes iniciales ± 5% @ 25°C Initial lumens ± 5% @ 25°C	2000 LM	3000 LM
Voltaje / Voltage	120/277 V~, 50/60Hz.	120/277 V~, 50/60 Hz.
Potencia / Watts Línea	28 W	42 W
Corriente / Input current	0,34 A	0,34 A
Factor de potencia / Power factor	>0.9	>0.9
THD / Distortion Armónica Total	<20%	<20%
Eficacia / Efficacy	91 lm / W	91 lm / W
Temperaturas de color / Color Temperatures	4000 °K 5000 °K	4000 °K 5000 °K
Supresor de sobrevoltaje serie / Surge protector device	10 Kv	10 Kv
Potencia Light Source	22 W	33 W

RAWELT, S.A. de C.V.

- Torreón, Coah., México
- Tel: 871 747 47 84 / Ventas: 800 999 20 18
- Whatsapp: +521 871 137 25 71
- torreon@rawelt.com.mx
- www.rawelt.com.mx



Serie V100 LED Sección 13.4 | **RW51**



**13.4 - LUMINARIA A PRUEBA DE INTEMPERIE LED. SERIE V 100 LED
CERRADAS Y SELLADAS.**

**13.4 - V 100 LED SERIES. LED WEATHERPROOF. LIGHTING FIXTURE WEATHERPROOF
ENCLOSED AND GASKETED.**

La familia V100 LED están disponibles en 2 tipos de temperatura de color: Blanco neutral y Blanco Frio, ambos proporcionan una iluminación uniforme, y están diseñadas para uso interno y externo. Utilizando una tablilla con arreglos de LED podemos superar la iluminación de 300 W de luz incandescente

The V 100 LED lighting fixtures are available in two types of color temperatures, neutral white and cool white, both has uniform illumination and are designed for interior or exterior use, using a LED arrangements can overcome 300 watts incandescent light.

Aplicaciones:

- Plantas procesadoras de alimentos, lecherías, panaderías, cervecerías y luces de emergencia, montajes bajos, cualquier tipo de habitación, etc.
- Se recomienda para evitar la contaminación de productos alimenticios por partículas del vaso de cristal roto.

Applications:

- Food processing plants, canneries, dairies, breweries bakeries and emergency lights, low ceiling, and any kind of room.
- Is recommended to avoid food contamination for particles from broken glasses.

Material:

- Aluminio inyectado a presión. Diseño robusto y de alta resistencia Diecast.
- Vaso de policarbonato resistente al calor.
- Pruebas en cámara salina a pintura de acuerdo a ASTM B117
- Pruebas de adherencia a pintura de acuerdo a ASTM 3359
- Resistencia a impactos mecánicos en cuerpo de acuerdo a IK09, gracias a su diseño que no cuenta con elementos susceptibles a rompimiento.
- Acabado: Pintura electrostática poliéster polimerizada por horneado espesor mínimo 2 mils. Asegurando una protección completa a corrosión y rayos UV en color gris.
- Tornillos de acero inoxidable.
- Empaque: Silicón.
- Se recomienda con empaques de silicón. Para uso NEMA 4,4X, IP65 y silicón en tapones.
- No para uso residencial, si el cable de alimentación es mayor de 90°C.
- Para usarse en áreas mojadas y húmedas cuando se tenga la luminaria hacia abajo.
- Roscas NPT asegurando continuidad a tierra.

Material:

- Diecast aluminum. Robust and heavy duty.
- Heat resistant polycarbonate globe.
- Saline chamber test to paint according to ASTM B117
- Paint adhesion test according ASTM 3359
- Resistance to mechanical impacts according IK09 body, thanks to its design that does not have elements susceptible to breakage.
- Finish: electrostatic powder coating polyester polymerized by oven minimum thickness 2 mils. Ensure a complete corrosion and UV rays protection grey color.
- Stainless steel screws.
- Gasket: Silicone.

Características:

- Distribución Fotométrica: IESNA Tipo II, Tipo III y Tipo HB-90°.
- Mantenimiento mínimo o nulo.
- Encendido instantáneo
- Operación a temperaturas bajas.
- Bajas temperaturas superficiales.
- El sistema de LED puede ahorrar hasta un 80% en costos de energía.
- 50 mil horas vida pueden proporcionar más de 10 años de iluminación sin necesidad de mantenimiento.
- No contiene mercurio ni productos químicos peligrosos.
- Temperaturas de operación: -30°C a 50°C.
- Lúmenes iniciales ± 5% @ 25°C.
- Excelente disipación de calor para una larga vida del LED, gracias a sus aletas exteriores.
- Protección contra variaciones de corriente mediante supresor de sobrevoltajes categoría c3 10Kv línea tierra.



**Fabricado en base a /
Manufactured in base to:**
UL 1598, UL 844
CSA C22.2 No. 250
UL 8750 LED
NMX-J-307-2017
NMX-J-627-2009
NMX-J-529-2012
NOM-064-SCFI-2014
NOM-030-ENER-2016
NOM-003-SCFI-2014
NOM-001-SCFI-2018
NOM-058-SCFI-2017
NOM-024-SCFI-2013

Vaso de policarbonato:

- Transparente como el cristal. Alta transmisión lumínica.
- Alta resistencia al calor.
- Clasificación de flamabilidad superior a UL 94 V-0/1.2 mm ó UL 94-5VA/3.0 mm 2600F1, 94HB, F1
- Alta resistencia física contra impacto, rayado o abrasión.
- Estabilidad y exactitud dimensional.
- Resistencia dieléctrica 32-35 kv/mm (1 mm de espesor de pared).
- Conserva sus propiedades físicas y químicas en un rango de temperatura de entre -40°C hasta 120°C.
- Carcasa conectada a tierra
- El desempeño real puede variar como resultado del medio ambiente y aplicación donde se instale la luminaria.
- Todos los parámetros son diseñados y medidos bajo condiciones de laboratorio a 25°C
- Rango de temperatura T5 para uso en la mayoría de ambientes peligrosos.
- Sellada de fábrica: Refierase al instructivo de instalación para requerimientos de sellado externo.
- Robusto y estilizado diseño de luminaria con sistema pasivo de disipación térmica gracias a sus estilizadas aletas para mantener los elementos electrónicos internos funcionando a una temperatura de operación adecuada y asegurando el enfriamiento mediante un flujo de aire por convección natural.

- Not for use in dwellings, when supply wire exceed 90 °C.
- Suitable for wet and damp locations when downlight only.
- Recommended silicon gasket for NEMA 4,4X, IP65 and silicone compound in plugs.
- NPT threaded to ensure ground continuity.

Characteristics:

- Photometric Distribution: IESNA Type II, Type III and Type HB-90°.
- Excellent heat dissipation for a long life of LEDs through the design of external flaps.
- Protection against current variations through voltage supresor category C3 10 kv line-ground
- Minimal maintenance.
- Instant ignition.
- Operation at low temperatures.
- Low surface temperatures.
- LED system can save up to 80% in energy costs.
- 50,000 hours of life can provide more than 10 years of lighting without maintenance.
- Contains no mercury and hazardous chemical products.
- Operation temperatures: -30 °C up to 50 °C.
- Initial lumens ± 5% @ 25 °C.

Polycarbonate globe:

- Clear and transparent globe, like glass.
- High heat resistance.
- Flamability classification up to UL 94 V-0/1.2 mm or UL 94-5VA/3.0 mm 2600F1, 94HB, F1
- High physical toughness against impacts and scratching.
- Dimensional accuracy and stability.
- Dielectric strength 32-35 kv/mm (1 mm wall thickness).
- Keeps its physical and chemical properties in a range of -40 °C up to 120 °C.
- Grounded housing.
- Real performance could vary as a result of application and environment where the lighting fixture are installed.
- All parameters are designed and measured under laboratory conditions at 25 °C.
- T5 temperature range for safe use in most hazardous environments.
- Factory sealed: Refer to installations instructions for external seal requirements.
- Robust and light luminaire design with pasive thermal dissipation system thanks to its stylish dissipation fins/blades to keep internal electronics elements at a suitable operating temperature ensure cooling by natural convection air flow.

USAR No. DE CODIGO PARA HACER PEDIDOS. TO ORDER USE CODE NUMBER.

Figura Figure	Descripción Description	Item	Catalogo Catalog	Código Code	Linea Line	Lúmenes Iniciales Initial Lumens	Grados Kelvin °K	Salida Hub size		Peso x 100 pzas. Weight x 100 pcs.		Unit Ctn. Pzas. Pcs.	Ship Ctn. Pzas. Pcs.
								mm	inch	kg	lb		
	Con soporte de montaje a pared, tapa para caja rectangular y vaso policarbonato. With wall mount, weatherproof single gang cover and polycarbonate globe.	1	VAPRP-01-LED-2	27.42.4148	28	2000	4000			200	440	1	
			VAPRP-01-LED-3	27.42.4149	42	3000	4000						
			VAPRP-01-LED-5	27.42.4151	28	2000	5000						
			VAPRP-01-LED-6	27.42.4152	42	3000	5000						

Especificaciones sujetas a cambio sin previo aviso. Specifications are subject to change without notice.

13.4 - LUMINARIA A PRUEBA DE INTEMPERIE LED. SERIE V 100 LED
CERRADAS Y SELLADAS.

Hoja: 2 / 10
Page:

13.4 - V 100 LED SERIES. LED WEATHERPROOF. LIGHTING FIXTURE WEATHERPROOF
ENCLOSED AND GASKETED.

FICHA TECNICA / TECHNICAL DATA

007 - RW - 359

USAR No. DE CODIGO PARA HACER PEDIDOS. TO ORDER USE CODE NUMBER.

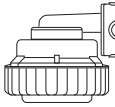
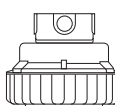
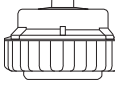
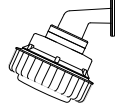
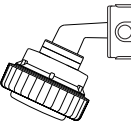
Figura Figure	Descripción Description	Item	Catalogo Catalog	Código Code	Linea Line	Lúmenes Iniciales Initial Lumens	Grados Kelvin °K	Salida Hub size		Peso x 100 pzas. Weight x 100 pcs.		Unit Ctn. Pzas. Pcs.	Ship Ctn. Pzas. Pcs.
								mm	inch	kg	lb		
	Con soporte de montaje a pared, caja CVX, vaso policarbonato y 4 tapones. With wall mount, CVX box, polycarbonate globe and 4 close-up plugs.	2	VAPXP-11-LED-2 VAPXP-11-LED-3 VAPXP-11-LED-5 VAPXP-11-LED-6	27.42.4154 27.42.4155 27.42.4157 27.42.4158	28 42 28 42	2000 3000 2000 3000	4000 4000 5000 5000	12.7	1/2	220	484	1	
		3	VAPXP-21-LED-2 VAPXP-21-LED-3 VAPXP-21-LED-5 VAPXP-21-LED-6	27.42.4160 27.42.4161 27.42.4163 27.42.4164	28 42 28 42	2000 3000 2000 3000	4000 4000 5000 5000	19.0	3/4	218	480	1	
	Con soporte de montaje a techo, caja CVX, vaso de policarbonato y 4 tapones. With ceiling mount, CVX box, polycarbonate globe and 4 close-up plugs.	4	VAXP-11-LED-2 VAXP-11-LED-3 VAXP-11-LED-5 VAXP-11-LED-6	27.42.4178 27.42.4179 27.42.4181 27.42.4182	28 42 28 42	2000 3000 2000 3000	4000 4000 5000 5000	12.7	1/2	220	484	1	
		5	VAXP-21-LED-2 VAXP-21-LED-3 VAXP-21-LED-5 VAXP-21-LED-6	27.42.4184 27.42.4185 27.42.4187 27.42.4188	28 42 28 42	2000 3000 2000 3000	4000 4000 5000 5000	19.0	3/4	218	480	1	
	Con soporte de montaje suspendido y vaso de policarbonato. With pendant mount and polycarbonate globe.	6	VASP-11-LED-2 VASP-11-LED-3 VASP-11-LED-5 VASP-11-LED-6	27.42.4190 27.42.4191 27.42.4193 27.42.4194	28 42 28 42	2000 3000 2000 3000	4000 4000 5000 5000	12.7	1/2	180	396	1	
		7	VASP-21-LED-2 VASP-21-LED-3 VASP-21-LED-5 VASP-21-LED-6	27.42.4196 27.42.4197 27.42.4199 27.42.4200	28 42 28 42	2000 3000 2000 3000	4000 4000 5000 5000	19.0	3/4	180	396	1	
	Con soporte de montaje a pared 25° y vaso de policarbonato. With 25° wall mount and polycarbonate globe.	8	VAIP-01-LED-2 VAIP-01-LED-3 VAIP-01-LED-5 VAIP-01-LED-6	27.42.4266 27.42.4267 27.42.4269 27.42.4270	28 42 28 42	2000 3000 2000 3000	4000 4000 5000 5000	12.7	1/2	200	440	1	
			Con soporte de montaje a pared 25°, caja CVX, vaso de policarbonato y 4 tapones. With 25° wall mount, CVX box, polycarbonate globe and 4 closure plugs.	9	VAIXP-11-LED-2 VAIXP-11-LED-3 VAIXP-11-LED-5 VAIXP-11-LED-6	27.42.4272 27.42.4273 27.42.4275 27.42.4276	28 42 28 42	2000 3000 2000 3000	4000 4000 5000 5000	19.0	3/4	220	484
10	VAIXP-21-LED-2 VAIXP-21-LED-3 VAIXP-21-LED-5 VAIXP-21-LED-6			27.42.4278 27.42.4279 27.42.4281 27.42.4282	28 42 28 42	2000 3000 2000 3000	4000 4000 5000 5000	19.0	3/4	218	480	1	

Especificaciones sujetas a cambio sin previo aviso. Specifications are subject to change without notice.

RAWELT, S.A. de C.V.

RAWELT® INYECTADOS
Una División del Grupo **REVUELTA**

13.4 - LUMINARIA A PRUEBA DE INTEMPERIE LED. SERIE V 100 LED
CERRADAS Y SELLADAS.

Hoja: 3 / 10
Page:

13.4 - V 100 LED SERIES. LED WEATHERPROOF. LIGHTING FIXTURE WEATHERPROOF
ENCLOSED AND GASKETED.

FICHA TECNICA / TECHNICAL DATA

007 - RW - 359

USAR No. DE CODIGO PARA HACER PEDIDOS. TO ORDER USE CODE NUMBER.

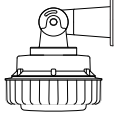
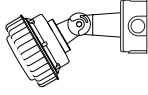
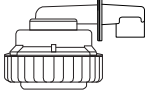
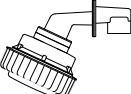
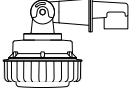
Figura Figure	Descripción Description	Item	Catalogo Catalog	Código Code	Linea Watts Line	Lúmenes Iniciales Initial Lumens	Grados Kelvin °K	Salida Hub size		Peso x 100 pzas. Weight x 100 pcs.		Unit Ctn. Pzas. Pcs.	Ship Ctn. Pzas. Pcs.
								mm	inch	kg	lb		
	Con soporte de montaje a pared regulable y vaso de policarbonato. With adjustable wall mount, and polycarbonate globe.	11	VAAP-01-LED-2	27.42.4284	28	2000	4000			200	440	1	
			VAAP-01-LED-3	27.42.4285	42	3000	4000						
			VAAP-01-LED-5	27.42.4287	28	2000	5000						
			VAAP-01-LED-6	27.42.4288	42	3000	5000						
	Con soporte de montaje a pared regulable caja CVX, vaso de policarbonato y 4 tapones. With adjustable wall mount, CVX box, polycarbonate globe and 4 closure plugs.	12	VAAXP-11-LED-2	27.42.4290	28	2000	4000	12.7	1/2	220	484	1	
			VAAXP-11-LED-3	27.42.4291	42	3000	4000						
			VAAXP-11-LED-5	27.42.4293	28	2000	5000						
		13	VAAXP-21-LED-2	27.42.4296	28	2000	4000	19.0	3/4	218	480	1	
			VAAXP-21-LED-3	27.42.4297	42	3000	4000						
			VAAXP-21-LED-5	27.42.4299	28	2000	5000						
	Con soporte de montaje a poste 90° y vaso de policarbonato. With 90° stanchion mount and polycarbonate globe.	14	VAPSP-41-LED-2	27.42.4304	28	2000	4000	31.8	1(1/4")	220	484	1	
			VAPSP-41-LED-3	27.42.4305	42	3000	4000						
			VAPSP-41-LED-5	27.42.4307	28	2000	5000						
			VAPSP-41-LED-6	27.42.4308	42	3000	5000						
		15	VAPSP-51-LED-2	27.42.4343	28	2000	4000	38.1	1(1/2")	218	480	1	
			VAPSP-51-LED-3	27.42.4344	42	3000	4000						
	Con soporte de montaje a poste 25° y vaso de policarbonato. With 25° stanchion mount and polycarbonate globe.	16	VAPISP-41-LED-2	27.42.4349	28	2000	4000	31.8	1(1/4")	220	484	1	
			VAPISP-41-LED-3	27.42.4350	42	3000	4000						
			VAPISP-41-LED-5	27.42.4352	28	2000	5000						
			VAPISP-41-LED-6	27.42.4353	42	3000	5000						
		17	VAPISP-51-LED-2	27.42.4355	28	2000	4000	38.1	1(1/2")	218	480	1	
			VAPISP-51-LED-3	27.42.4356	42	3000	4000						
	Con soporte de montaje a poste regulable y vaso de policarbonato. With adjustable station mount and polycarbonate globe.	18	VAPASP-41-LED-2	27.42.4361	28	2000	4000	31.8	1(1/4")	220	484	1	
			VAPASP-41-LED-3	27.42.4362	42	3000	4000						
			VAPASP-41-LED-5	27.42.4364	28	2000	5000						
			VAPASP-41-LED-6	27.42.4365	42	3000	5000						
		19	VAPASP-51-LED-2	27.42.4367	28	2000	4000	38.1	1(1/2")	218	480	1	
			VAPASP-51-LED-3	27.42.4368	42	3000	4000						
	VAPASP-51-LED-5	27.42.4370	28	2000	5000								
	VAPASP-51-LED-6	27.42.4371	42	3000	5000								

Especificaciones sujetas a cambio sin previo aviso. Specifications are subject to change without notice.

RAWELT, S.A. de C.V.

RAWELT® INYECTADOS
Una División del Grupo REVUELTA

13.4 - LUMINARIA A PRUEBA DE INTEMPERIE LED. SERIE V 100 LED
CERRADAS Y SELLADAS.

Hoja: 4 / 10
Page:

13.4 - V 100 LED SERIES. LED WEATHERPROOF. LIGHTING FIXTURE WEATHERPROOF
ENCLOSED AND GASKETED.

FICHA TECNICA / TECHNICAL DATA

007 - RW - 359

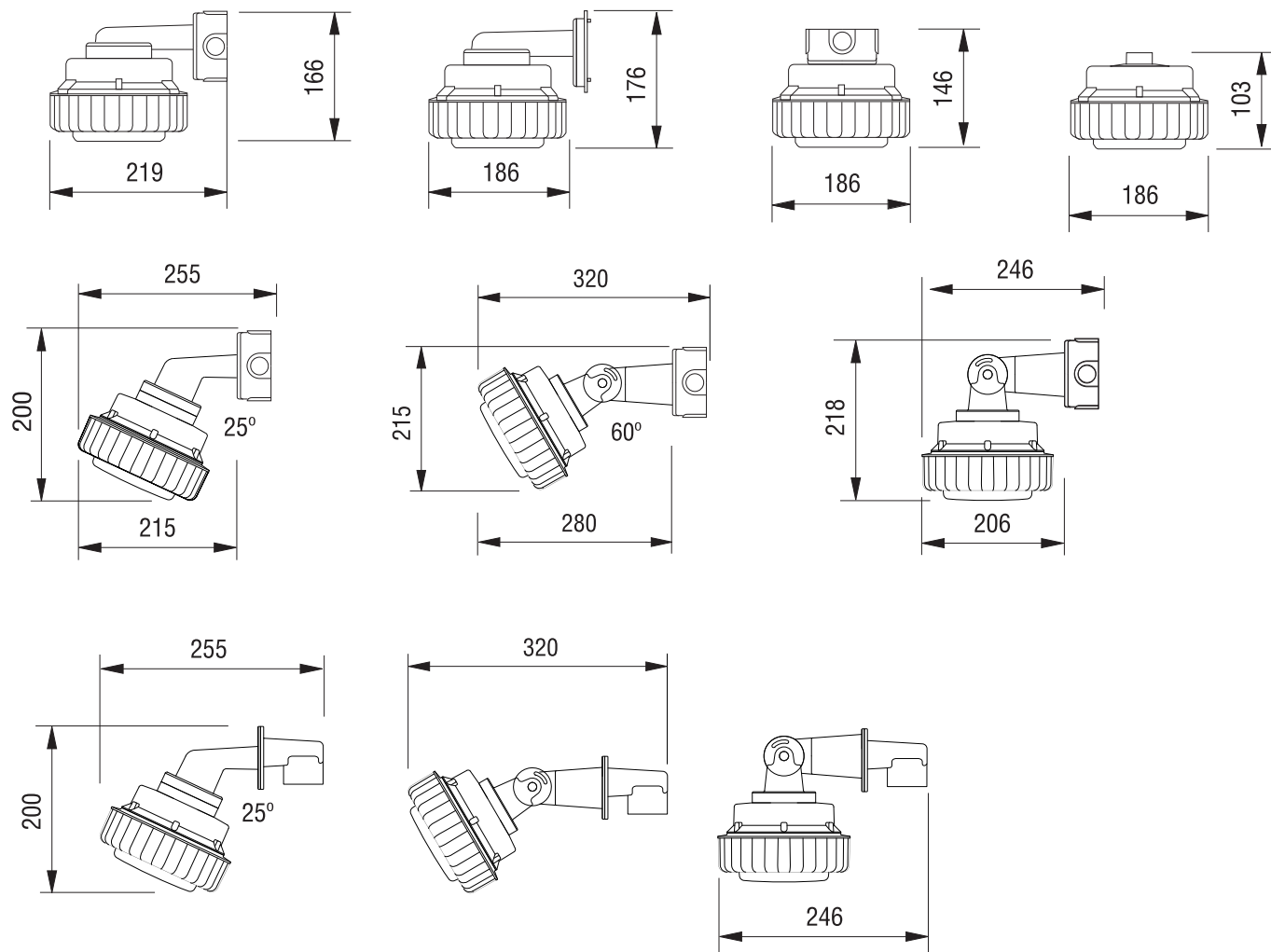

13.4 - LUMINARIA A PRUEBA DE INTEMPERIE LED. SERIE V 100 LED
CERRADAS Y SELLADAS.

Hoja: 5 / 10
Page:

13.4 - V 100 LED SERIES. LED WEATHERPROOF. LIGHTING FIXTURE WEATHERPROOF
ENCLOSED AND GASKETED.

FICHA TECNICA / TECHNICAL DATA

007 - RW - 359

Sistema Electrónico / Electronic system:

LED

Tablilla de arreglo LED.
Blanco Neutral (4000 °K) CRI 80.
Blanco Frio (5000 °K) CRI 80.

LED

High brightness LED assembly.
White Neutral (4000 °K) CRI 80.
Cool White (5000 °K) CRI 80.

DRIVER

Balastro electrónico de corriente continua
120 / 277 V~, 50/60 Hz.
Factor de potencia: FP > 0.90
Distorsión armónica total: THD < 20%

DRIVER

Constant current regulated power supply
120 / 277 V~, 50/60 Hz.
Power factor: > 0.90
Low harmonic distortion: THD < 20%

Especificaciones eléctricas / Electrical ratings:

Lúmenes iniciales ± 5% @ 25 °C Initial lumens ± 5% @ 25 °C	2000 LM	3000 LM
Voltaje / Voltage	120 / 277 V~, 50/60Hz	120 / 277 V~, 50/60 Hz
Potencia / Watts	28 W	42 W
Corriente / Input current	0,34 A	0,34 A
Factor de potencia / Power factor	>0.9	>0.9
THD / Distortion Armonica Total	<20%	<20%
Eficacia / Efficacy	91 lm / W	91 lm / W
Temperaturas de color / Color Temperatures	4000 °K 5000 °K	4000 °K 5000 °K
Supresor de Sobrevoltaje Serie/ Surge Protector Device	10 KV	10 KV
Potencia / Light source	22 W	33 W

Factor multiplicador de corrección de temperatura ambiente y lúmenes Ambient temperature and lumens correction factor multiplier	
0 °C	1.02
10	1.01
25	1.00
40	0.99
50	0.97

Para seleccionar la distribución fotométrica, añada al final del catálogo el sufijo II para tipo II, sufijo III para tipo III y sufijo HB para tipo HB-90°.

To select the photometric distribution, add at the final of catalogue the suffix II for type II, suffix III for type III and suffix HB for type HB-90°.

Especificaciones sujetas a cambio sin previo aviso. Specifications are subject to change without notice.

RAWELT, S.A. de C.V.

RAWELT ® INYECTADOS
Una División del Grupo **REVUELTA**

13.4 - LUMINARIA A PRUEBA DE INTEMPERIE LED. SERIE V 100 LED
CERRADAS Y SELLADAS.

Hoja: 6 / 10
Page:

13.4 - V 100 LED SERIES. LED WEATHERPROOF. LIGHTING FIXTURE WEATHERPROOF
ENCLOSED AND GASKETED.

FICHA TECNICA / TECHNICAL DATA

007 - RW - 359

LUMINARIA A PRUEBA DE VAPOR LED

Marca: RAWELT

Modelo: LAV-LED

Para uso Interior y exterior

Fuente de Luz: LED

CARACTERÍSTICAS ELÉCTRICAS:
CONSULTAR ETIQUETA EN EL PRODUCTO
120/277 V~ 50/60 Hz

Contenido 1 pieza

NOM

País de origen: México

Fabricado por: Rawelt, S.A. DE C.V.
VALLE DEL GUADIANA 656 PARQUE INDUSTRIAL
LAGUNERO 35070 GÓMEZ PALACIO, DGO., MÉXICO

RAWELT, S.A. de C.V.

RAWELT ® INYECTADOS
Una División del Grupo **REVUELTA**

14 - VII - 2025

LUMINAIRE PHOTOMETRIC TEST REPORT

Test:U:127.0V I:0.2647A P:33.47W PF:0.9958 Lamp Flux:2669.36x1 lm		
NAME: Lampara a prueba de vapor	TYPE:Industrial	WEIGHT:1.753Kg
SPEC.:127V 34W 50-60Hz	DIM.: 190x190x110 (mm)	SERIAL No.:
MFR.: Rawelt	SUR.:-	PROTECTION ANGLE:

DATA OF LAMP		PHOTOMETRIC DATA			Eff: 79.76 lm/W
MODEL	VASP-11-LED-5	I _{max} (cd)	1354	S/MH(C0/180)	1.11
NOMINAL POWER(W)	34	LOR(%)	100.0	S/MH(C90/270)	1.07
RATED VOLTAGE(V)	127	TOTAL FLUX(lm)	2669.4	η UP, DN(C0-180)	0.0, 49.8
NOMINAL FLUX(lm)	2669.36	CIE CLASS	DIRECT	η UP, DN(C180-360)	0.0, 50.2
LAMPS INSIDE	1	η up(%)	0.0	CIBSE SHR NOM	1.25
TEST VOLTAGE(V)	127.1	η down(%)	100.0	CIBSE SHR MAX	1.25

LUMINOUS INTENSITY DISTRIBUTION DIAGRAM

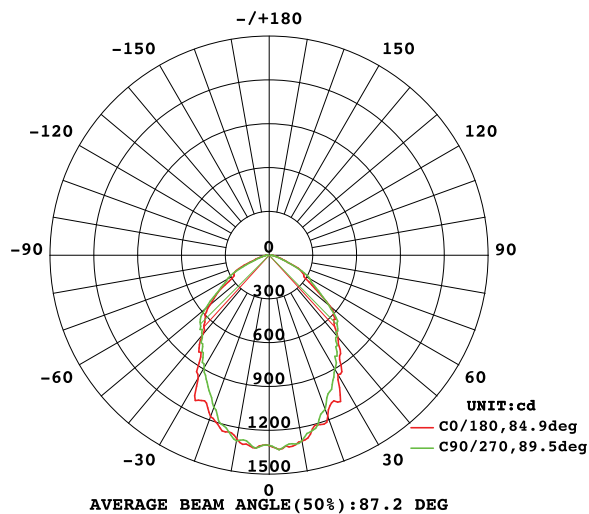

C0 PLANE ISOLUX DIAGRAM (UNIT:lx)

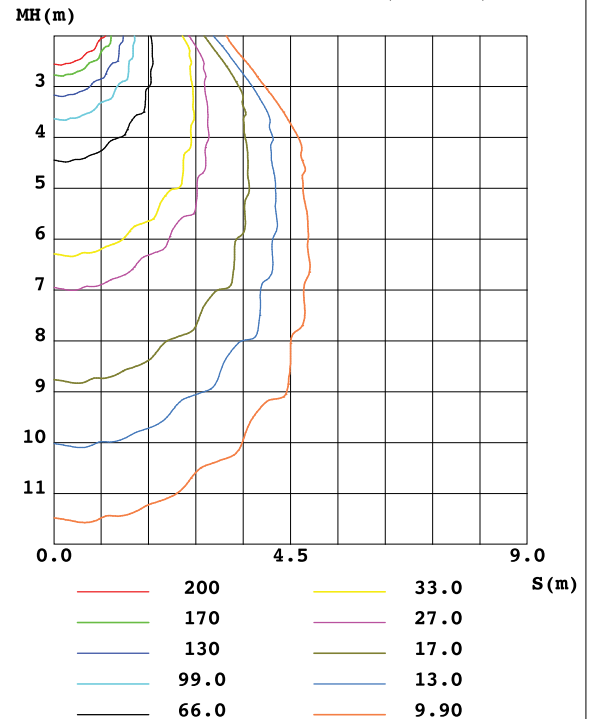

C Range: 0 - 360DEG
 C Interval: 10.0DEG
 Test Speed: HIGH
 Temperature: 25.0DEG
 Operators: Everardo Torres
 Test Date: 2015-06-23

γ Range: 0 - 90DEG
 γ Interval: 1.0DEG
 Test System: EVERFINE GO-2000A_V1 SYSTEM V2.0.279
 Humidity: 65.0%
 Test Distance: 6.960m [K=1.0000]
 Remarks:

Especificaciones sujetas a cambio sin previo aviso. Specifications are subject to change without notice.

13.4 - LUMINARIA A PRUEBA DE INTEMPERIE LED. SERIE V 100 LED
CERRADAS Y SELLADAS.

Hoja: 8 / 10
Page:

13.4 - V 100 LED SERIES. LED WEATHERPROOF. LIGHTING FIXTURE WEATHERPROOF
ENCLOSED AND GASKETED.

FICHA TECNICA / TECHNICAL DATA

007 - RW - 359

ISOLUX DIAGRAM

Test:U:127.0V I:0.2647A P:33.47W PF:0.9958 Lamp Flux:2669.36x1 lm		
NAME: Lampara a prueba de vapor	TYPE:Industrial	WEIGHT:1.753Kg
SPEC.:127V 34W 50-60Hz	DIM.: 190x190x110 (mm)	SERIAL No.:
MFR.: Rawelt	SUR.:-	PROTECTION ANGLE:

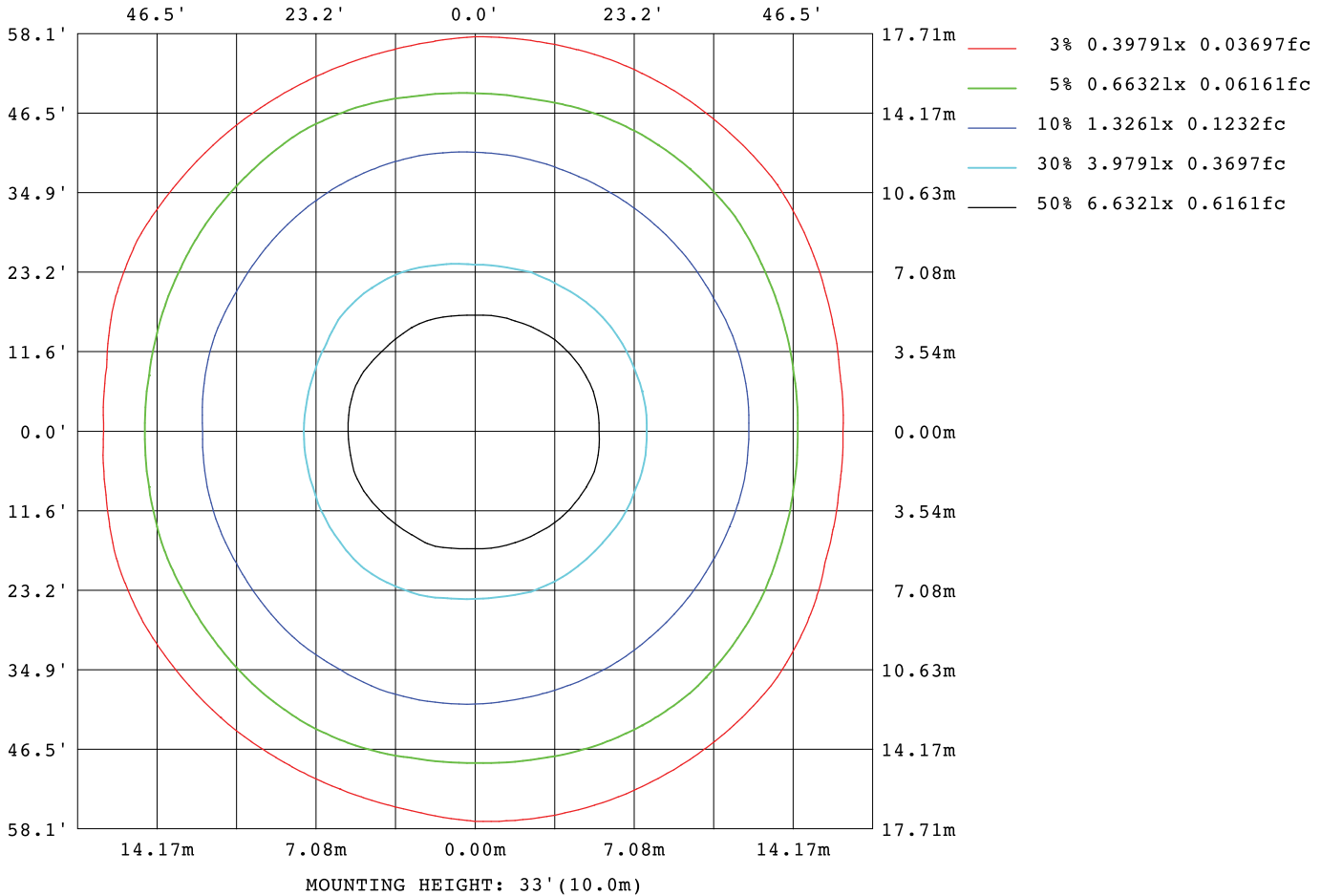

C Range: 0 - 360DEG
C Interval: 10.0DEG
Test Speed: HIGH
Temperature:25.0DEG
Operators:Everardo Torres
Test Date:2015-06-23

γ Range: 0 - 90DEG
γ Interval: 1.0DEG
Test System:EVERFINE GO-2000A_V1 SYSTEM V2.0.279
Humidity:65.0%
Test Distance:6.960m [K=1.0000]
Remarks:

Especificaciones sujetas a cambio sin previo aviso. Specifications are subject to change without notice.

RAWELT, S.A. de C.V.

RAWELT® INYECTADOS
Una División del Grupo **REVUELTA**

Planar Illuminance Curve

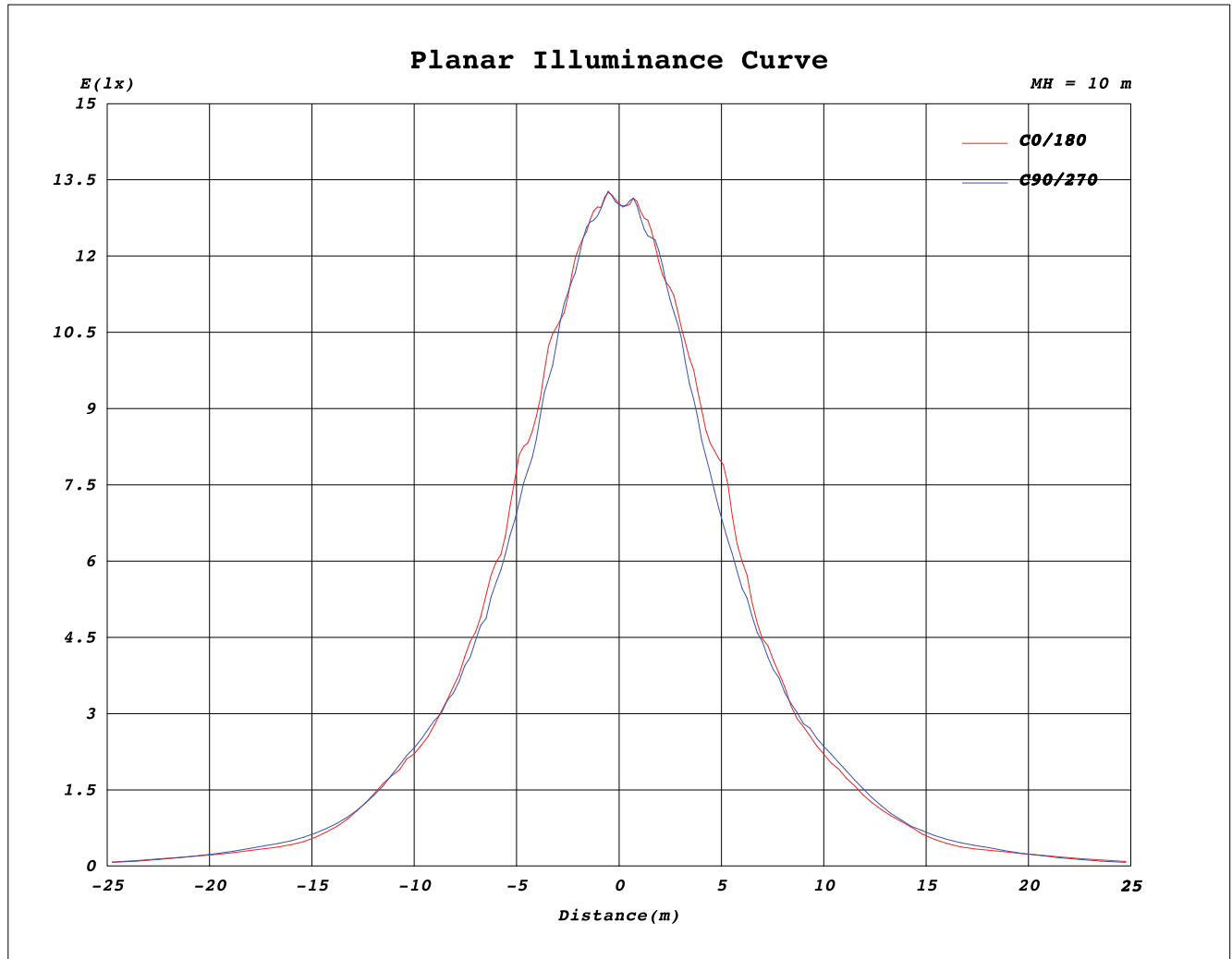

C Range: 0 - 360DEG
C Interval: 10.0DEG
Test Speed: HIGH
Temperature: 25.0DEG
Operators: Everardo Torres
Test Date: 2015-06-23

γ Range: 0 - 90DEG
 γ Interval: 1.0DEG
Test System: EVERFINE GO-2000A_V1 SYSTEM V2.0.279
Humidity: 65.0%
Test Distance: 6.960m [K=1.0000]
Remarks:

Especificaciones sujetas a cambio sin previo aviso. Specifications are subject to change without notice.

13.4 - LUMINARIA A PRUEBA DE INTEMPERIE LED. SERIE V 100 LED
CERRADAS Y SELLADAS.

Hoja: 10 / 10
Page:

13.4 - V 100 LED SERIES. LED WEATHERPROOF. LIGHTING FIXTURE WEATHERPROOF
ENCLOSED AND GASKETED.

FICHA TECNICA / TECHNICAL DATA

007 - RW - 359

AAI Figure

Test:U:127.0V I:0.2647A P:33.47W PF:0.9958 Lamp Flux:2669.36x1 lm		
NAME: Lampara a prueba de vapor	TYPE:Industrial	WEIGHT:1.753Kg
SPEC.:127V 34W 50-60Hz	DIM.: 190x190x110 (mm)	SERIAL No.:
MFR.: Rawelt	SUR.:-	PROTECTION ANGLE:

Flux out:1632 lm

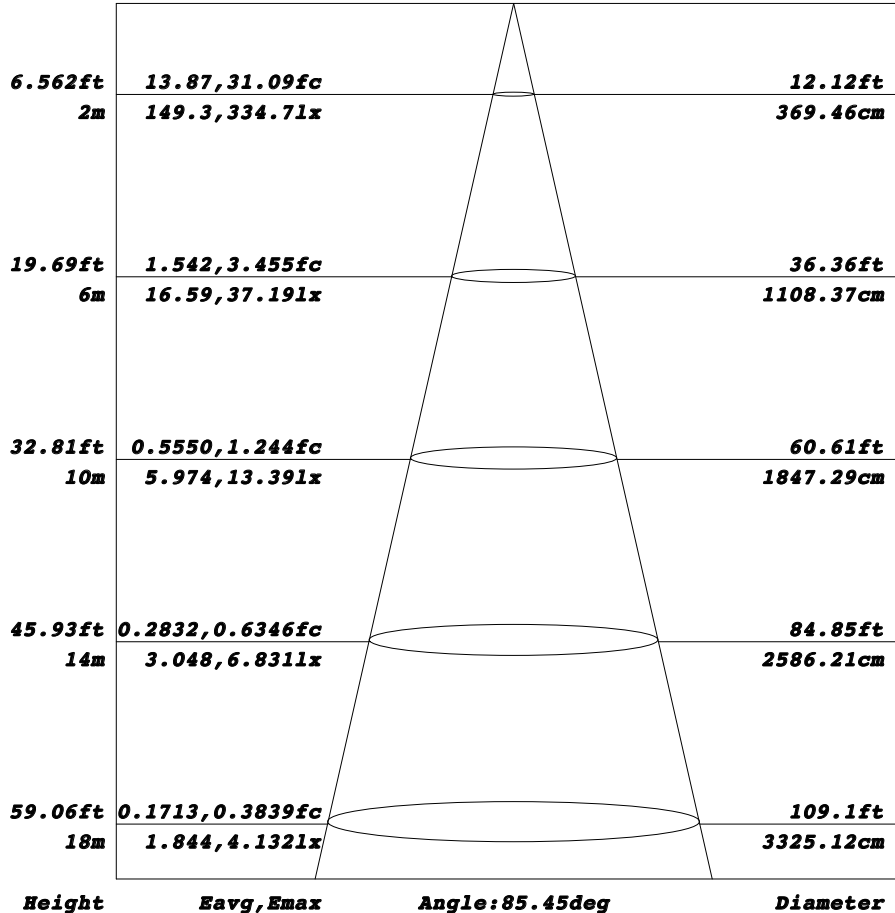

Note: The Curves indicate the illuminated area and the average illumination when the luminaire is at different distance.

C Range: 0 - 360DEG
C Interval: 10.0DEG
Test Speed: HIGH
Temperature: 25.0DEG
Operators: Everardo Torres
Test Date: 2015-06-23

γ Range: 0 - 90DEG
γ Interval: 1.0DEG
Test System: EVERFINE GO-2000A_V1 SYSTEM V2.0.279
Humidity: 65.0%
Test Distance: 6.960m [K=1.0000]
Remarks:

Especificaciones sujetas a cambio sin previo aviso. Specifications are subject to change without notice.

RAWELT, S.A. de C.V.

RAWELT © INYECTADOS
Una División del Grupo **REVUELTA**

Cotización/Quotation Plazo de embarque* / Shipment exw* :

Pedido No./Purchase order :

Our ref.:

Fecha/Date: Vendedor/Salesman: No.

Facturar a/Invoice to: RFC:

Ordenado por/Ordered by: Tel. () Fax ()

Dirección/Address:

..... C.P./Zip. Lugar/City/Country:

Consignar a/Ship to:

..... Embarcar: Camión x Cobrar Pagado Paquete

Cond. de Pago/Terms:

Cond. de Venta/Sale conditions: L.P.:

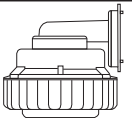
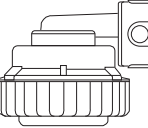
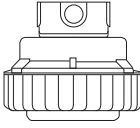
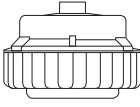
13.4 - LUMINARIA A PRUEBA DE INTEMPERIE LED. SERIE V 100 LED.								
13.4 - V 100 LED SERIES. LED WEATHERPROOF LIGHTING FIXTURE.								
Figura Figure	Descripción Description	Item.	Código Code	Salida Hub size		Unit. Ctn. Pzas. Pcs.	Ship. Ctn. Pzas. Pcs.	Cantidad Qty.
				mm	inch			
	Con soporte de montaje a pared, tapa para caja rectangular y vaso de policarbonato. With wall mount, weatherproof single gang cover and polycarbonate globe.	1	27.42.4148 27.42.4149 27.42.4151 27.42.4152			1		
	Con soporte de montaje a pared, caja CVX, vaso de policarbonato y 4 tapones. With wall mount, CVX box, polycarbonate globe and 4 close-up plugs.	2	27.42.4154 27.42.4155 27.42.4157 27.42.4158	12.7	1/2	1		
		3	27.42.4160 27.42.4161 27.42.4163 27.42.4164	19.0	3/4	1		
	Con soporte de montaje a techo, caja CVX, vaso de policarbonato y 4 tapones. With ceiling mount, CVX box, polycarbonate globe and 4 close-up plugs.	4	27.42.4178 27.42.4179 27.42.4181 27.42.4182	12.7	1/2	1		
		5	27.42.4184 27.42.4185 27.42.4187 27.42.4188	19.0	3/4	1		
	Con soporte de montaje suspendido y vaso de policarbonato. With pendant mount and polycarbonate globe.	6	27.42.4190 27.42.4191 27.42.4193 27.42.4194	12.7	1/2	1		
		7	27.42.4196 27.42.4197 27.42.4199 27.42.4200	19.0	3/4	1		

Producción Almacén Embarques Control Expediente

Cotización/Quotation Plazo de embarque* / Shipment exw* :

Pedido No./Purchase order :

Our ref.:

Fecha/Date: Vendedor/Salesman: No.

Facturar a/Invoice to: RFC.

Ordenado por/Ordered by: Tel. () Fax ()

Dirección/Address:





C.P./Zip: Lugar/City/Country:

Consignar a/Ship to:

Embarcar: Camión x Cobrar Pagado Paquete

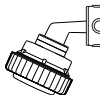
Cond. de Pago/Terms:

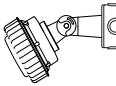
Cond. de Venta/Sale conditions: L.P.:

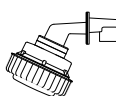
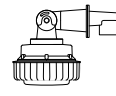
13.4 - LUMINARIA PRUEBA DE INTEMPERIE LED. SERIE V 100 LED.		V 100 LED SERIES. LED WEATHERPROOF LIGHTING FIXTURE.						
Figura Figure	Descripción Description	Item.	Código Code	Salida Hub size		Unit. Ctn. Pzas. Pcs.	Ship. Ctn. Pzas. Pcs.	Cantidad Qty.
				mm	inch			
	Con soporte de montaje a pared 25° y vaso de policarbonato. With 25° wall mount and polycarbonate globe.	8	27.42.4266 27.42.4267 27.42.4269 27.42.4270			1		
	Con soporte de montaje a pared 25°, caja CVX, vaso de policarbonato y 4 tapones. With 25° wall mount, CVX box, polycarbonate globe and 4 closure plugs.	9	27.42.4272 27.42.4273 27.42.4275 27.42.4276	12.7	1/2	1		
		10	27.42.4278 27.42.4279 27.42.4281 27.42.4282	19.0	3/4	1		
	Con soporte de montaje a pared regulable y vaso de policarbonato. With adjustable wall mount and polycarbonate globe.	11	27.42.4284 27.42.4285 27.42.4287 27.42.4288			1		
	Con soporte de montaje a pared regulable, caja CVX, vaso de policarbonato y 4 tapones. With adjustable wall mount, CVX box, polycarbonate globe and 4 closure plugs.	12	27.42.4290 27.42.4291 27.42.4293 27.42.4294	12.7	1/2	1		
		13	27.42.4296 27.42.4297 27.42.4299 27.42.4300	19.0	3/4	1		
	Con soporte de montaje a poste 90° y vaso de policarbonato. with 90° stanchion mount and polycarbonate globe.	14	27.42.4304 27.42.4305 27.42.4307 27.42.4308	31.8	1(1/4")	1		
		15	27.42.4343 27.42.4344 27.42.4346 27.42.4347	38.1	1(1/2")	1		
	Con soporte de montaje a poste 25° y vaso de policarbonato. with 25° stanchion mount and polycarbonate globe.	16	27.42.4349 27.42.4350 27.42.4352 27.42.4353	31.8	1(1/4")	1		
		17	27.42.4355 27.42.4356 27.42.4358 27.42.4359	38.1	1(1/2")	1		
	Con soporte de montaje a poste regulable y vaso de policarbonato. with adjustable stanchion mount and polycarbonate globe.	18	27.42.4361 27.42.4362 27.42.4364 27.42.4365	31.8	1(1/4")	1		
		19	27.42.4367 27.42.4368 27.42.4370 27.42.4371	38.1	1(1/2")	1		

Expediente
 Control
 Embarques
 Almacén
 Producción