

Caja Redonda Uso Rudo

RAWELT®

A prueba de intemperie.



CSX



CVX

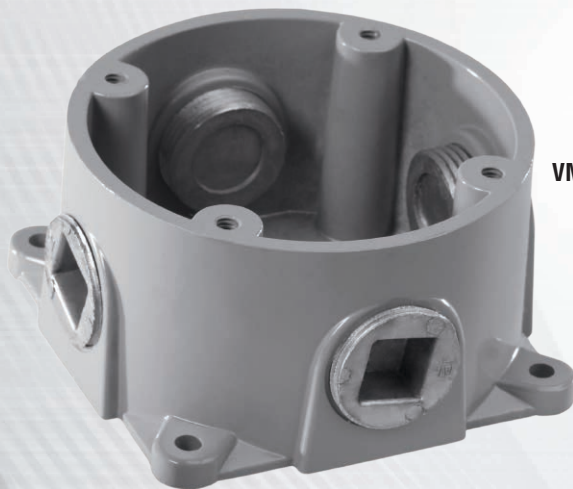

VMX



VMX



LISTED
1M70

Weatherproof heavy duty
Round outlet box.



CVX



- Material: Aluminio Inyectado a presión (diecast).
- Acabados: Pintura electrostática epoxica/poliester polimerizada.
- A prueba de intemperie cuando se usa tapa con empaque y silicon en todas las aberturas y rosca de los tapones. NEMA 4,4 X.
- Rosca NPT para usarse con tubo conduit RIGIDO e IMC, para asegurar la continuidad a tierra.
- Diametros de las cajas de 3 1/2", 4" y 4 1/2".
- Se surte con 5 bocas roscadas y 4 tapones en 1/2 (12.7 mm), 3/4" (19.0 mm), y 1" (25.4 mm).
- Tornillo de tierra incluido.
- Los agujeros roscados sin salida para los tornillos de la tapa evitan daños al cable durante la instalación y asegura la caja a prueba de agua.

APLICACIONES.

- Caja de conexiones de uso general.
- Caja de conexiones para accesorios colgantes.
- En instalaciones de tubo conduit RIGIDO e IMC. Permite fácil acceso para mantenimiento y aberturas para hacerse empalmes y derivaciones.

- Material: Diecast aluminum.
- Finish: Electrostatic powder epoxy/poliester coating.
- For wet location when gasketed cover are used and silicone sealing compound in all openings and in threaded plugs. NEMA 4,4X.
- NPT threaded for use with RIGID and IMC conduit, to ensure ground continuity.
- Boxes diameters in 3 1/2", 4" and 4 1/2".
- Furnished with 5 tapped holes and 4 threaded close-up plugs.
- Hub sizes: 1/2" (12.7 mm), 3/4" (19.0 mm), 1" (25.4 mm).
- Green ground screw included.
- Tapped blind hole on cover prevent conductor damage during installation, provide water-tightness.

APPLICATIONS.

- Splice box for general purpose.
- Splice box for pendant fixtures..
- In installations of threaded RIGID and IMC conduit. Provide openings for making splice and taps. Allows access for maintenance.

TAPAS REDONDAS

**Cumple con /
Compliances:
UL 514 A
CAN/CSA-C22.2
No. 18-92**



TCSX



TSX



TVMX



Manufacturing and Integration 100% National.
Made in Mexico

RAWELT, S.A. de C.V.

Torreón, Coah., México
Tel: 871 747 47 84 / Ventas: 800 999 20 18
torreon@rawelt.com.mx



www.rawelt.com.mx

RAWELT
Una División del Grupo REVUELTA

Sección 15.3 | **RW49**

24-03

15.3 - CAJA REDONDA USO RUDO A PRUEBA DE INTEMPERIE. 114 (4 1/2). SERIE VMX.

15.3 - WEATHERPROOF HEAVY DUTY 4 1/2 (114) ROUND OUTLET BOX. VMX SERIES.

FICHA TECNICA / TECHNICAL DATA

007 - RW - 276

- Material: Aluminio inyectado a presión (diecast).
- Acabados: Pintura electrostática epóxica/poliéster polimerizada espesor mínimo de 2 mils
- Pruebas en cámara salina a pintura de acuerdo a ASTM B117
- Pruebas de adherencia a pintura de acuerdo a ASTM 3359
- Resistencia a impactos mecánicos en cuerpo de acuerdo a IK09, gracias a su diseño que no cuenta con elementos susceptibles a rompimiento.
- A prueba de intemperie cuando se usa tapa con empaque. NEMA 4, 4X
- Rosca NPT para usarse con tubo conduit RIGIDO e IMC, asegurando continuidad a tierra.
- Se surte con 5 bocas roscadas y 4 tapones roscados.
- Medidas de bocas: 12.7 (1/2), 19.05 (3/4), 25.4 (1).
- Tornillo de tierra pasivado incluido.
- 4 agujeros para montaje.
- Los agujeros sin salida para los tornillos de la tapa evitan daños al cable durante la instalación y asegura la caja a prueba de agua.

- Material: Diecast aluminum.
- Finish: Electrostatic powder coating epoxic/polyester. Minimum thickness 2 mils.
- Saline chamber test to paint according to ASTM B117.
- Paint adhesion test according ASTM 3359.
- Resistance to mechanical impacts according IK09 body, thanks to its design that does not have elements susceptible to breakage.
- For wet locations when gasketed cover are used. NEMA 4, 4X
- NPT threaded for use with RIGID and IMC conduit, to ensure ground continuity.
- Furnished with 5 tapped holes and 4 threaded close-up plugs.
- Hub sizes: 1/2 (12.7), 3/4 (19.05), 1 (25.4).
- Green ground screw included.
- Four mounting holes.
- Blank cover screw holes prevent conductor damage during installation, provide water-tightness.

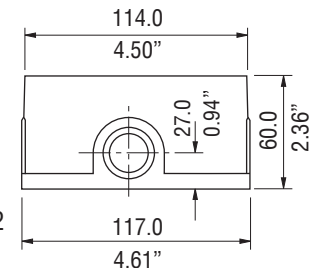
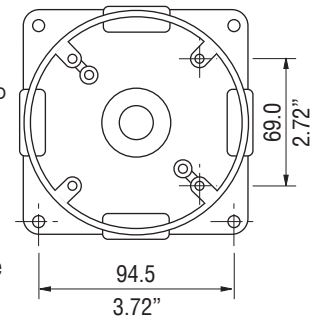

APLICACIONES.

- Permite fácil acceso para mantenimiento.
- Fabricación en base a: UL 514 A
CAN/CSA-C22.2 No. 18-92

APPLICATIONS.

- Provide openings for making splice and taps.
- Allows access for maintenance.
- Manufactured in compliance with: UL 514 A
CAN/CSA-C22.2 No. 18-92

USAR No. DE CODIGO PARA HACER PEDIDOS. TO ORDER USE CODE NUMBER.

Figura Figure	Descripción Description	Catalogo Catalog	Código Code	Salida Hub size		Peso x 100 pzas. Weight x 100 pcs.		Pqt. Unit Pzas. Pcs.	Unit Ctn. Pzas. Pcs.	Ship Ctn. Pzas. Pcs.	Std. Pkg. Pzas. Pcs.
				mm	inch	kg	lb				
	Caja redonda VMX 114 (4 1/2) 5 ø, con 4 tapones.	VMX-10	27.09.3359	12.7	1/2	47.6	104.7				24
	4 (102) CSX round outlet box 5 hubs, with 4 close-up plugs.	VMX-20	27.09.3360	19.0	3/4	47.6	104.7				24
		VMX-30	27.09.3361	25.4	1	47.6	104.7				24
	Tapa redonda ciega TVMX 114 (4 1/2), con empaque y tornillos.	TVMX	27.09.3362			10.0	22.0	1	40	160	
	4 1/2 (114) TVMX round blank cover, with gasket and screws.										
	Tapa redonda TVMX 114 (4 1/2) 1 ø roscado, con empaque y tornillos.	TVMX-10	27.09.3363	12.7	1/2	11.5	25.3	1	12	48	70
	4 1/2 (114) TVMX round one hub cover, with gasket and screws.	TVMX-20	27.09.3364	19.0	3/4	10.0	22.0	1	12	48	70
		TVMX-30	27.09.3365	25.4	1	9.0	19.8	1	12	48	70
	Empaque EVMX 114 (4 1/2). EVMX gasket 4 1/2 (114).	EVMX	27.08.3282			10.0	22.0	10	140	560	
	Tapón roscado.	TA-0371	01.04.0371	12.7	1/2	1.0	2.2	25	200	2000	
	Close-up plug.	TA-0368	01.04.0368	19.0	3/4	1.3	2.9	25	100	1000	
		TA-2632	01.04.2632	25.4	1	1.7	3.7	25	100	1000	

Certificaciones / Compliances: Expediente/File No. E135600

Especificaciones sujetas a cambio sin previo aviso. Specifications are subject to change without notice.

RAWELT, S.A. de C.V.

RAWELT ® INYECTADOS
Una División del Grupo **REVUELTA**

Cotización/Quotation Plazo de embarque* / Shipment exw* :

Pedido No./Purchase order :

Our ref.:

Fecha/Date: Vendedor/Salesman: No.

Facturar a/Invoice to: RFC.

Ordenado por/Ordered by: Tel. () Fax ()

Dirección/Address:





..... C.P./Zip. Lugar/City/Country:

Consignar a/Ship to:

..... Embarcar: Camión x Cobrar Pagado Paquete

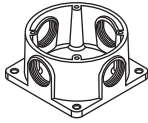
Cond. de Pago/Terms:

Cond. de Venta/Sale conditions: L.P.:

15.3 - SERIE VMX. CAJA REDONDA USO RUDO A PRUEBA DE INTEMPERIE 114 (4 1/2)									
15.3 - VMX SERIES. WEATHERPROOF HEAVY DUTY ROUND OUTLET BOX. 4 1/2 (114)									
Figura Figure	Código Code	Salida Hub size		Pqt. Unit Pzas. Pcs.	Unit Ctn. Pzas. Pcs.	Ship Ctn. Pzas. Pcs.	Std. Pkg. Pzas. Pcs.	Cantidad Qty.	<input type="checkbox"/> Expediente
		mm	inch						
	27.09.3359	12.7	1/2				24		<input type="checkbox"/> Control
	27.09.3360	19.0	3/4				24		
	27.09.3361	25.4	1				24		
	27.09.3362			1	40	160			<input type="checkbox"/> Embarques
	27.09.3363	12.7	1/2	1	12	48	70		<input type="checkbox"/> Almacén
	27.09.3364	19.0	3/4	1	12	48	70		
	27.09.3365	25.4	1	1	12	48	70		
	27.08.3282			10	140	560			<input type="checkbox"/> Producción
	01.04.0371	12.7	1/2	25	200	2000			<input type="checkbox"/>
	01.04.0368	19.0	3/4	25	100	1000			
	01.04.2632	25.4	1	25	100	1000			

- Antes de fincar el pedido en firme, favor de confirmar con fábrica el plazo de embarque definitivo.
- Before place your order, please confirm with RAWELT definitive date of shipment.